

SYMBOL DEFINITION		MISSING NUMBERS	
THE NUMBER INSIDE THE SYMBOL  CORRESPONDS TO THE NUMBER ON THE INSPECTION REPORT FOR THIS DRAWING/PART NUMBER	TOTAL NO. OF SYMBOLS ON DRAWING	15	
	LAST NO. USED	28	

DWG STATUS				ZONE	REVISION HISTORY			AUTH	DR	CK	APVD	
DATE	STG	REV	CHG	N/P								
16FE99	R	D4	-	-		REDRAWN TO PD & UPDATED PDM ATTRIBUTES			190264	HGH	GMC	JH

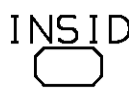

- NOTES
- UNLESS OTHERWISE SPECIFIED AND/OR INDICATED: DIMENSIONS ARE TO FACE OF VIEW SHOWN AND AUTOMATICALLY ROUNDED BY COMPUTER FOR INSPECTION. (SEE MATH MODEL FOR PRECISE DIMENSIONS.) FOR ALL OTHER DIMENSIONS NOT SHOWN BUT REQUIRED FOR TOOL BUILD, SEE MATH MODEL FOR PRECISE TOOL PATH DATA.
 - THIS PART IS NOT CONTROLLED FOR AUTOMATIC FEEDING.
 - MATING COMPONENTS OR EQUIVALENT: CONNECTOR 12052197
 - 480 SERIES - MAX. CABLE DIA. THAT WILL FIT PART IS 4.5.
 - 150 SERIES - MAX. CABLE DIA. THAT WILL FIT PART IS 2.5.

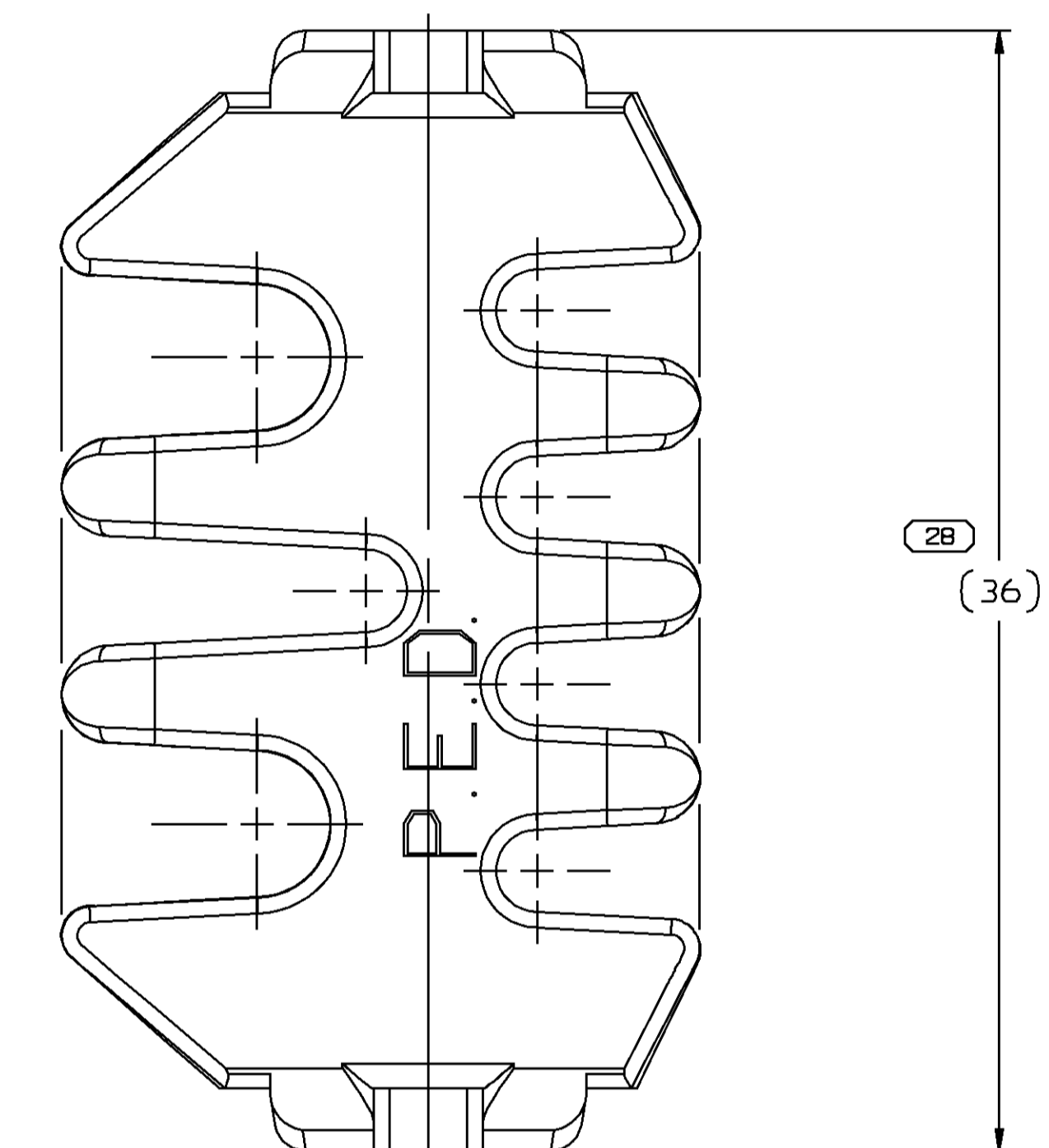
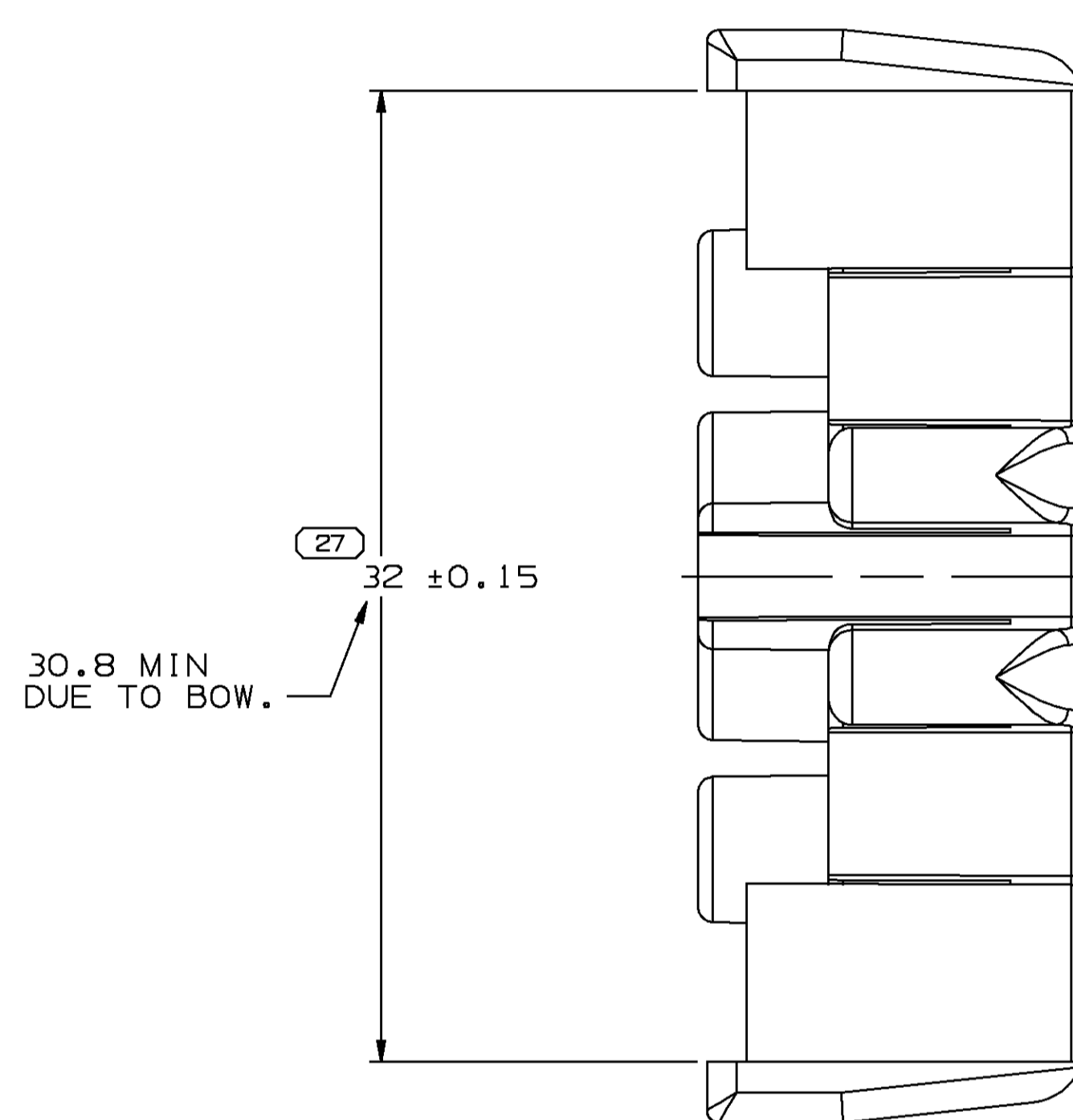
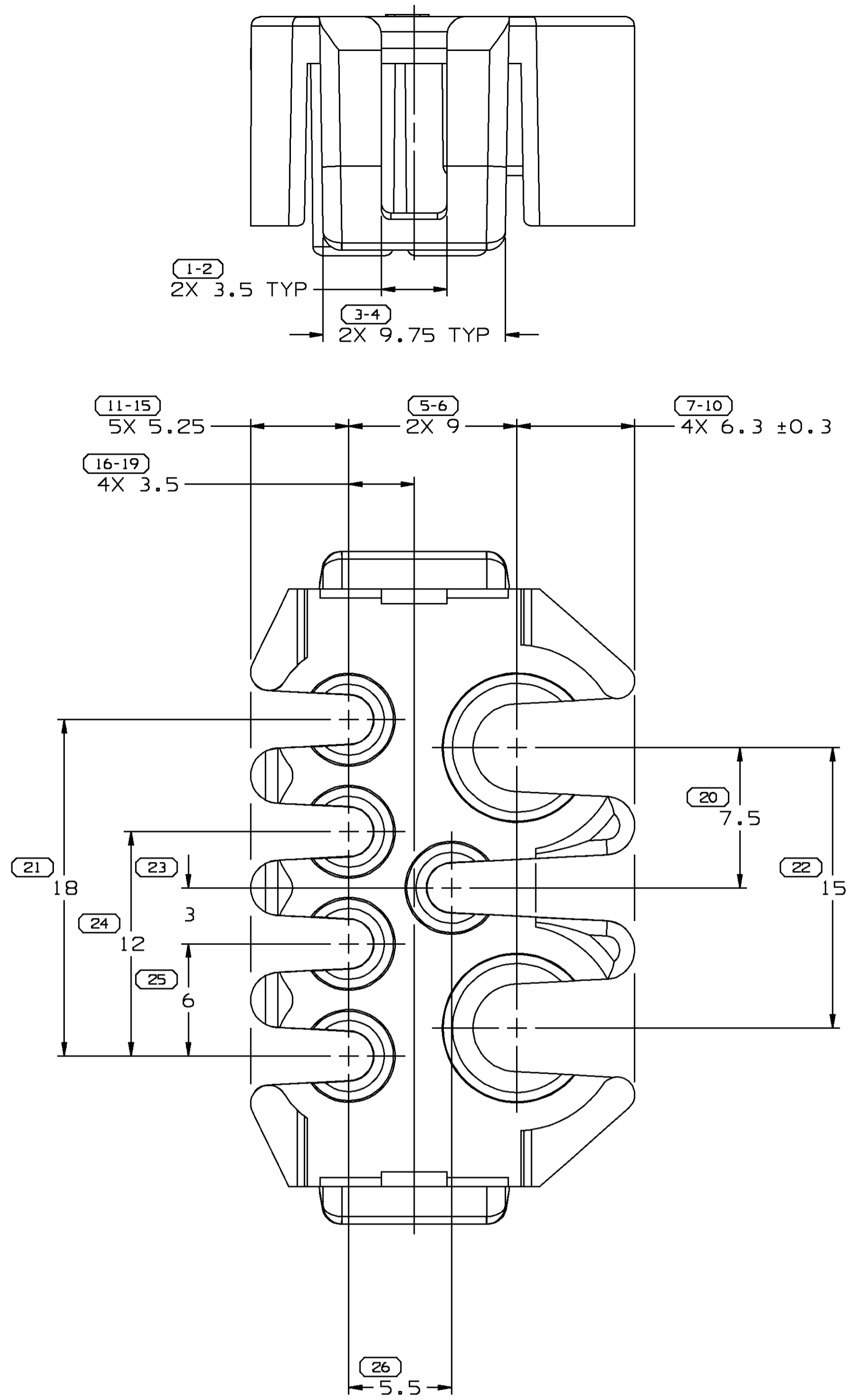
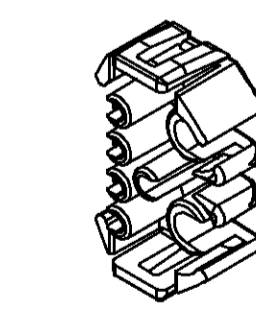

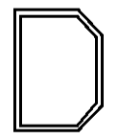
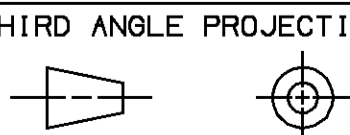
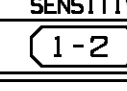
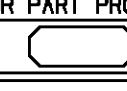
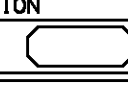
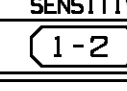
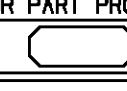
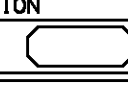
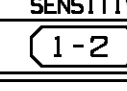
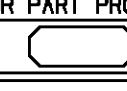
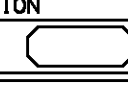
DELPHI Automotive Systems																																	
MATERIAL SPEC R0071784 PA66 HS IM-GRA MD		<table border="1"> <thead> <tr> <th colspan="4">DIMENSIONAL RANGE (MM)</th> <th>CHART E</th> </tr> <tr> <th>FROM</th> <th>TO</th> <th>> 20</th> <th>> 30</th> <th>> 70</th> </tr> </thead> <tbody> <tr> <td>0</td> <td>20</td> <td>30</td> <td>70</td> <td>100</td> </tr> <tr> <td colspan="5">TOLERANCE UNLESS OTHERWISE SPECIFIED</td> </tr> <tr> <td colspan="5">±0.15 ±0.2 ±0.3 ±0.4 ±0.5</td> </tr> <tr> <td colspan="5">ANGULAR TOLERANCE ± 2°</td> </tr> </tbody> </table>		DIMENSIONAL RANGE (MM)				CHART E	FROM	TO	> 20	> 30	> 70	0	20	30	70	100	TOLERANCE UNLESS OTHERWISE SPECIFIED					±0.15 ±0.2 ±0.3 ±0.4 ±0.5					ANGULAR TOLERANCE ± 2°				
DIMENSIONAL RANGE (MM)				CHART E																													
FROM	TO	> 20	> 30	> 70																													
0	20	30	70	100																													
TOLERANCE UNLESS OTHERWISE SPECIFIED																																	
±0.15 ±0.2 ±0.3 ±0.4 ±0.5																																	
ANGULAR TOLERANCE ± 2°																																	
PART DRAWING																																	
CODE NUMBER 6900	DWG DATE 23NOB4	SCALE 5:1																															
QC SPEC	STYLE	VOLUME cm³ 2.695																															
PART GEOMETRY 3D SOLID		UNLESS OTHERWISE SPECIFIED: PERFECT FORM REQUIRED FOR FEATURES OF SIZE AT MMC. TRUE POSITION TOLERANCES AND RELATED DATUMS APPLY AT CONDITION OF SIZE INDICATED IN FEATURE CONTROL FRAME. ALL OTHER GEOMETRIC TOLERANCES AND RELATED DATUMS APPLY RFS. SEPARATE TRUE POSITION CALLOUTS MAY BE GAGED SEPARATELY, REGARDLESS OF DATUM REFERENCE.																															
COPY OF MATH DATA DO NOT SCALE		REFERENCE 001,701	DATE																														
		DR APVD1 H. GAMA APVD2 G. MACIAS APVD3 J. HORIUCHI APVD4 APVD5	16FE99 16FE99 23FE99																														
METRIC UNLESS OTHERWISE SPECIFIED, ALL DIMENSIONS ARE IN MILLIMETERS		DRAWING NAME TPA M/P 150,480																															
THIRD ANGLE PROJECTION 		SHEET NUMBER 1 OF 1	DRAWING NUMBER 12052486																														
<table border="1"> <thead> <tr> <th colspan="4">THE DIMENSION NUMBER(S) SHOWN BELOW INDICATE DIMENSIONS THAT ARE PROCESS SENSITIVE FOR PART PRODUCTION</th> </tr> </thead> <tbody> <tr> <td>(1-2)</td> <td></td> <td></td> <td></td> </tr> </tbody> </table>		THE DIMENSION NUMBER(S) SHOWN BELOW INDICATE DIMENSIONS THAT ARE PROCESS SENSITIVE FOR PART PRODUCTION				(1-2)				<table border="1"> <thead> <tr> <th colspan="3">DWG STATUS</th> <th>SIZE</th> </tr> <tr> <th>STG</th> <th>REV</th> <th>N/P</th> <th></th> </tr> </thead> <tbody> <tr> <td>R</td> <td>D4</td> <td>-</td> <td>A1</td> </tr> </tbody> </table>		DWG STATUS			SIZE	STG	REV	N/P		R	D4	-	A1										
THE DIMENSION NUMBER(S) SHOWN BELOW INDICATE DIMENSIONS THAT ARE PROCESS SENSITIVE FOR PART PRODUCTION																																	
(1-2)																																	
DWG STATUS			SIZE																														
STG	REV	N/P																															
R	D4	-	A1																														

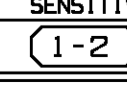
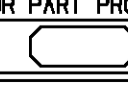
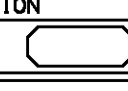
THE DIMENSION NUMBER(S) SHOWN BELOW INDICATE DIMENSIONS THAT ARE PROCESS SENSITIVE FOR PART PRODUCTION			
(1-2)			

DWG STATUS			SIZE
STG	REV	N/P	
R	D4	-	A1